

KOLB CoatedProducts®

Coated corrugated board for
undreamt-of advantages

HANS KOLB 
COATED PRODUCTS

besser Verpacken ...

... with **HANS KOLB** Wellpappe.

It's a claim that is also a promise. A promise that we'll provide an impressive variety of packaging solutions which are new every day.

*It was back in 1933 that Hans Kolb first founded what has now become one of the most successful family-owned companies in the corrugated-board business. Corrugated board forms the basis of the packaging solutions from **KOLB**. Simply explained we are architects for your products „home“. Your customized packaging solution will be created by our team of **KOLB Design**, the R&D division of **KOLB**.*

The convincing criteria for reaching your packaging goals is a modern production environment and, above all, the know-how of more than 1.000 committed employees.



Index

- 4** The Company
 - 7** **CORSTAT™/CORTRONIC®**
 - 25** **CORRUST®**
 - 31** **SKINBOARD®**
CORRUST SKINBOARD®
 - 36** Special coatings
 - 39** **KOLB** Logistics & Service
-

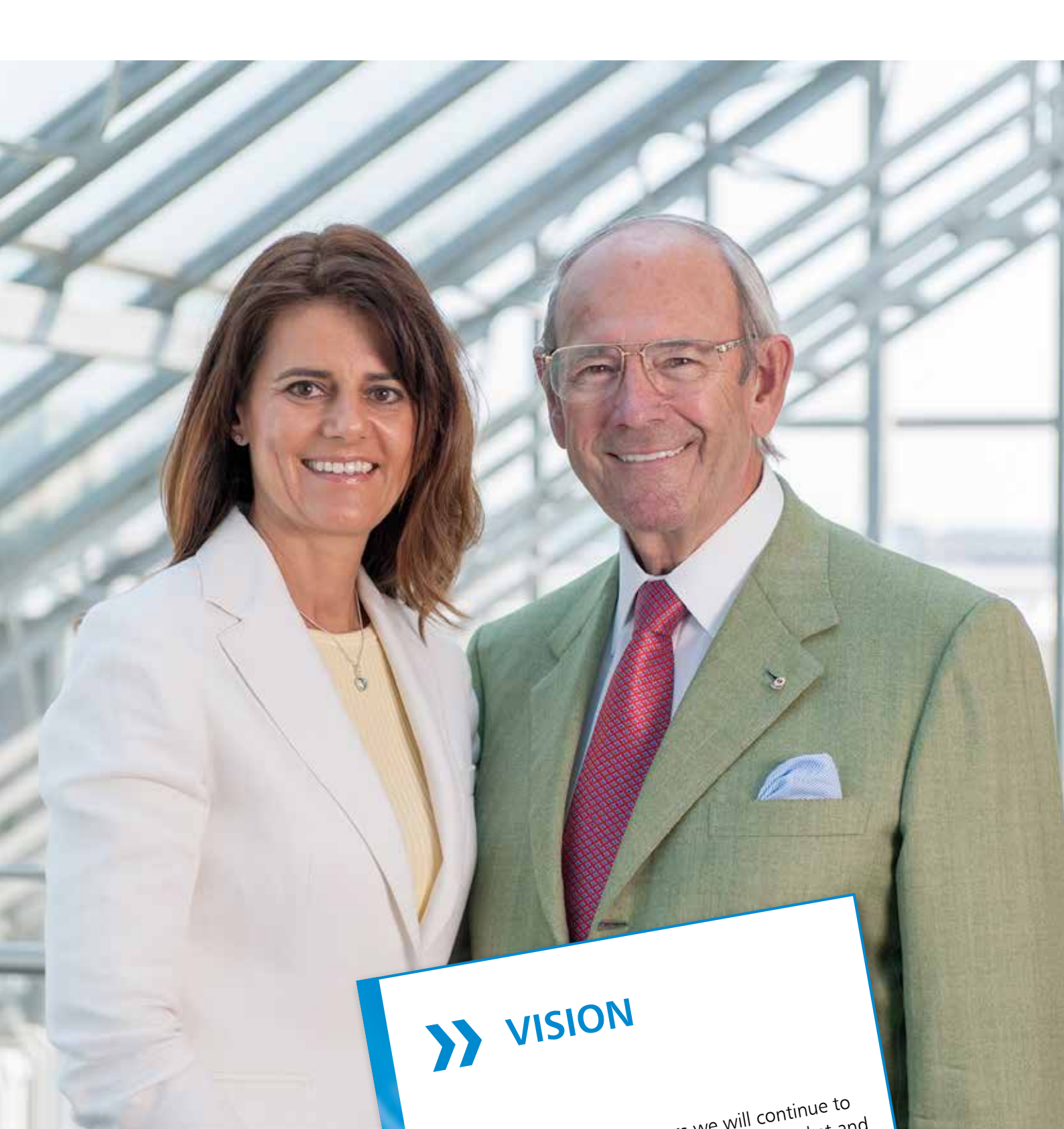

»» VISION

Together with our customers we will continue to respond to all the requirements of the market and accompany them with constant innovations.

Angela Kolb and Alwin J. Kolb

The Company

Our passion is both developing and producing corrugated board packaging solutions. Our claim „besser verpacken!“ is more than just saying KOLB packaging solutions are better. Instead KOLB offers a wide range of developing and logistical service. As a family-owned company based in one of the most beautiful parts of Southern Germany, the Allgaeu, we have been grown together with our customers over the past eight decades.

As early as in 1933 the basis for our success was established. Since then the Hans Kolb Group has developed step by step to an internationally active company. We develop and produce packages, packaging materials and special products of corrugated cardboard. Our main duty is to face the market's new challenges quickly and flexibly.

Packaging needs to conform to various requirements. Here KOLB packaging development continues along a tailor-made path. According our motto "better packaging" the **KOLB Design** team with its long experience utilizes the most modern creativity systems.

Numerous different solutions can be tested and created, which always gives you the advantage. Highest flexibility is our demand and at the same time our promise when it comes to the development of the perfect packaging solution.

As producer of environmentally friendly recyclable products, HANS KOLB Wellpappe commits itself to a binding environmental policy to a great extent.

Our company has always given significant value to the gentle handling of raw materials as well as the application of ecological energy in modern production procedures. Through our determination to protect the environment – binding for the whole of the company as well as for each individual employee – we adopted an exemplary position in the field of ecological protection. In this context we produce, for example, our own energy in terms of electricity and steam at our papermill HANS KOLB Papier.

... this is what our claim stands for:

besser verpacken!

Sustainability Through Tradition

Long before the topic of sustainability was discussed in daily matters, it was exactly this course of action which was rooted in our company "genes". We base this on products which have long been certified with **FSC** and which are produced at all sites. Even the papermill HANS KOLB Papier pursues this self-concept as certified by independent institutions. Moreover, we have always had a compact circular flow of raw materials within our own raw paper production since edge trimmings and die-cutting waste are directly recycled to high-quality raw paper with added waste paper of suppliers in our region.

However, this is not enough: our company culture with flat hierarchies and an extremely short decision taking process permanently keeps us on the cutting edge – however, without forgetting what we have already reached and the consequent experience. An above-average job tenure is another impressive fact which proves this.

Moreover, we socially stand by our origins: as sponsor of the **"Kinderbrücke Allgaeu e.V."** (association to help children) we support this organization from the beginning of their work since over the past 10 years.

One of our shareholders is also member of the committee to make decisions in order to support sick children innocently afflicted with distress here in the region. This is done without bureaucracy, with the necessary comprehension or simply with "the heart in the right place".

Speaking of region: the majority of our production and administration locations are in the "Allgaeu". However, where farms used to be the most important economic mainstay in earlier times, it is now a balanced and – at the same time – specialized branch structure that characterizes the economic site of the Allgaeu. Since our foundation in 1933, we have grown with our customers and are proud to have many long-time business relationships. This is the basis for our requirement to continue to meet the market's growing demands in the future – since this is exactly what we understand by sustainability.

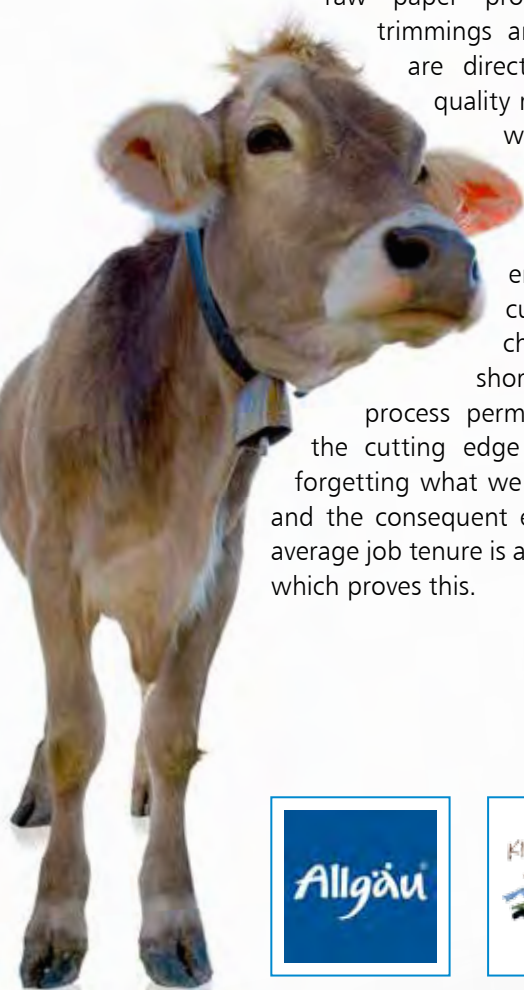

CORSTAT™
CORTRONIC®



... When There Is A Spark!

CORSTAT™ CORTRONIC®

IEC and EN Standards

Standards play an important part in reducing uncertainties in the evaluation, selection and use of ESD protection programs and products. Today in Europe, the operating standard is IEC 61340-5-1.

CORTRONIC® meets or exceeds IEC 61340-5 requirements pertaining to packaging of ESDS during transport and shipping.

Electrostatic Protected Area

All containers and working appliances in the ESD protected area must be of diverting nature in order to make a controlled potential equalization respectively the grounding possible.



Anti-oxidation Protection

All ESD protective packagings can additionally be equipped with an active, temporary and volatile corrosion inhibitor (VCI).

Electrostatic Discharge ESD

To a greater or lesser extent all contact between objects, every separation of one item from another, each sliding of one thing on another, causes a disturbance of electrical charge. When charge disturbances take place faster than charge redistribution, static charge accumulates. ESD occurs where charges of different electrostatic potentials meet. The flow of electrons is usually sudden and releases energy that can damage electrostatic sensitive devices (ESDS).

The Answer

To protect ESDS from the unwanted effects of ESD, two key measures must be taken and applied at all times:

- ESDS must be handled exclusively in an ESD Protected Area (EPA) where electrostatic potential differences are minimised.
- ESDS should be transported from one EPA to another preferably only in shielded packages.

CORTRONIC® is an ideally suited packaging for ESDS and because of its static dissipative skin and buried conductive core, it is an ESD shielding material suitable for use in ESD protected areas.

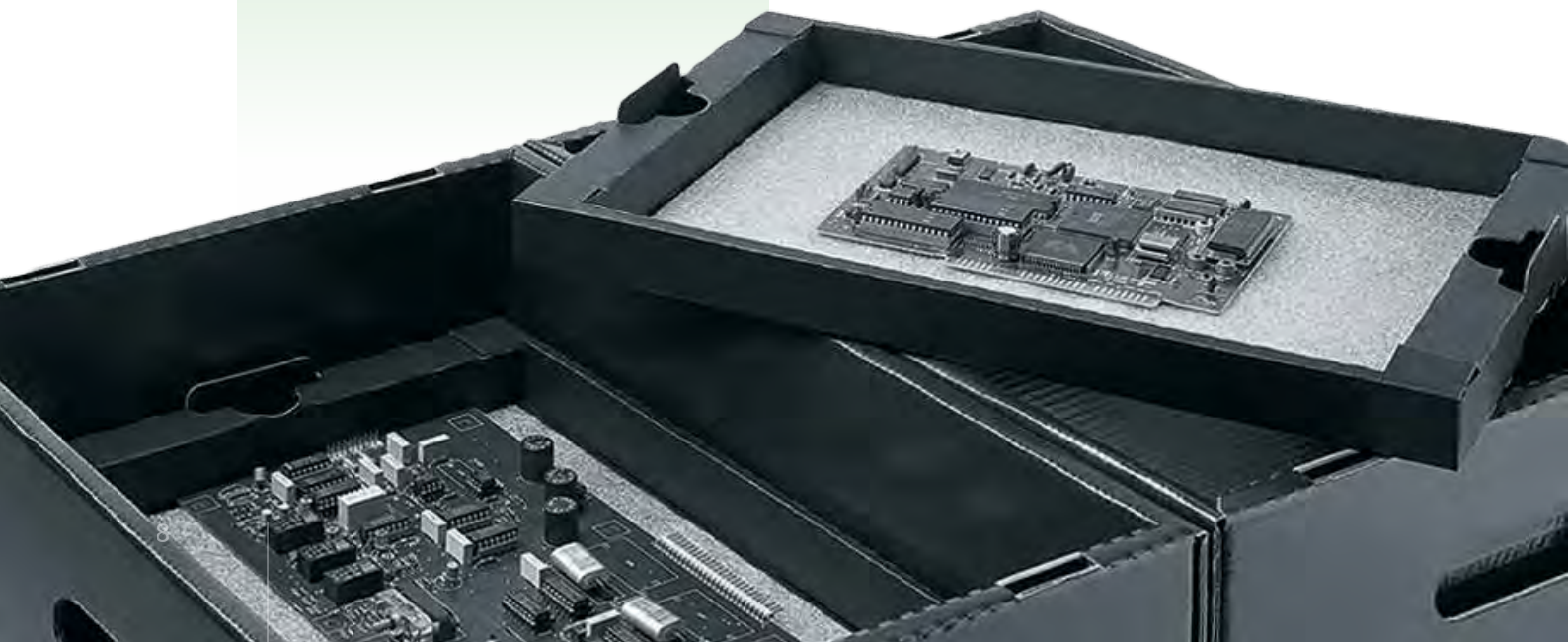

**Permanent conductive –
no time limit**

**CORSTAT™ and CORTRONIC® for safe use inside and
outside of the EPA**

CORTRONIC® $\approx 10^{7-8}$ diverting layer Ohm
 $< 10^2$ shielding layer Ohm

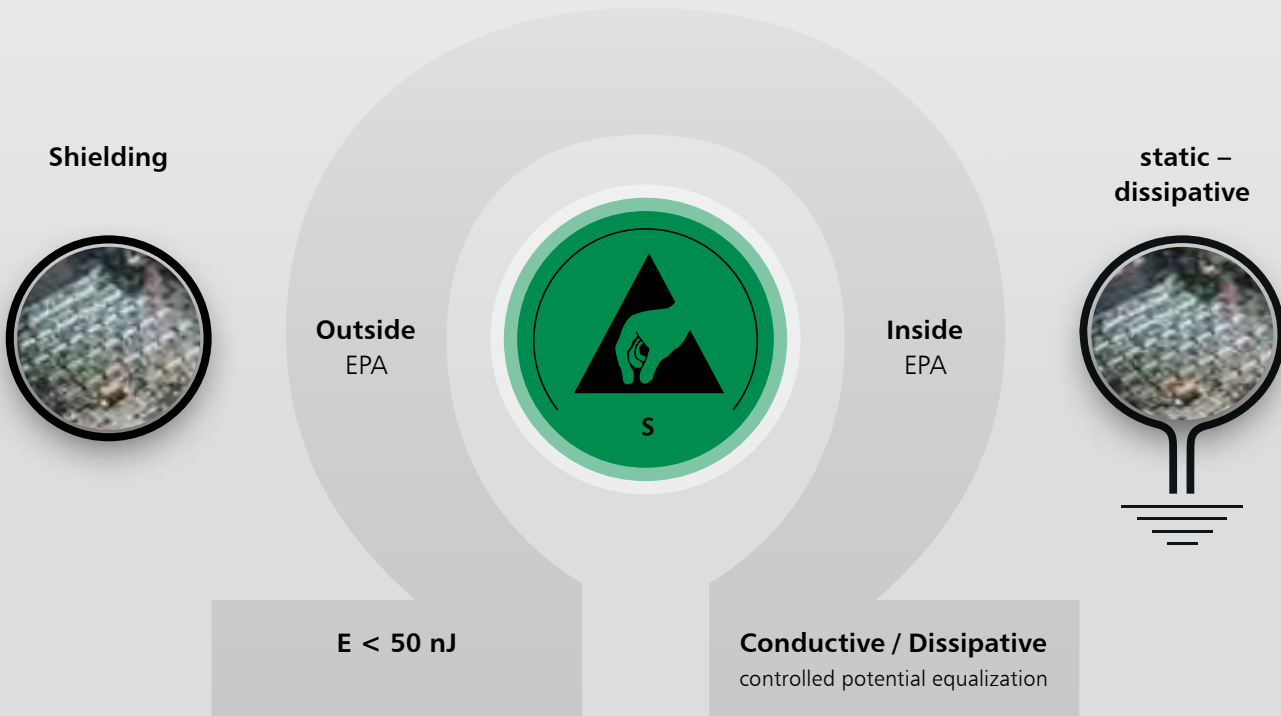

Applications

CORSTAT™ and **CORTRONIC®** is a proven, versatile cardboard ESD shielding material developed especially for today's electronic industry. Products made of **CORTRONIC®** include component boxes, PCB transit boxes, IC tube boxes, inplant handlers for PCBs and custom applications.

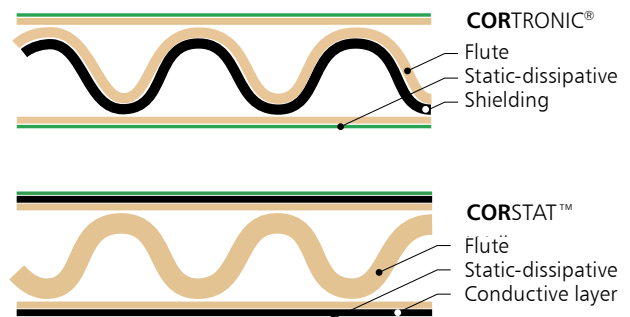

CORSTAT™ CORTRONIC®

Technical Facts	CORSTAT™	CORTRONIC®
Electrical		
Surface resistance Core layer (1- or 2-layer) No heavy metall		< 10 ²
Surface resistance of integrated mid layer	< 10 ⁴	
Surface resistance outer layer	10 ⁵⁻⁶	10 ⁷⁻⁸
Controlled potential equalization	yes	yes
Tribocharging	none	none
Surface colours	Black	Blue as a standard
Energy Bag Test ANSI / ESD STM 11-31 IEC 61340-4-8	< 20 nJ	< 10 nJ
Chemical		
Corrosion	none	none
Galvanic potetial	none	none
Recyclability	Resy 0062	Resy 0062
Mechanical		
Resistance to abrasion (varnished surface)	yes	yes
Printability	limited	limited
Moisture	no limitation of the electrical features	no limitation of the electrical features
Specifications		
Equivalent of	ANSI/ESD S541	ANSI/ESD S541
Equivalent of	DIN EN 61340-5-3	DIN EN 61340-5-3
Protected by	Patent given	Patent given
No subject to RoHS-guidelines (2002/95/EG and 2002/96/EG)		
Weight example		
L 600 W 400 H 120 mm	0,58 kg	0,58 kg

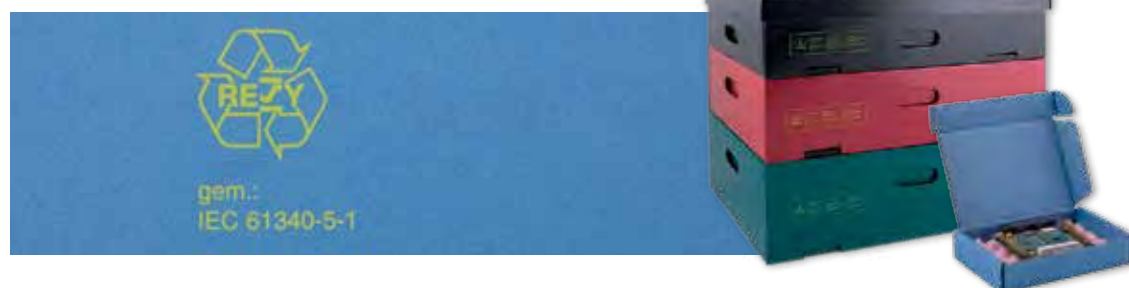



The Environment

CORTRONIC® packaging can withstand repeated use without loss of electrical properties. In the end, it can be recycled in the waste paper stream.



CORSTAT™ CORTRONIC®



AVAILABILITY

of our complete product range of
CORSTAT™ und **CORTRONIC®**
from stock

**User information for
CORSTAT™/CORTRONIC®/DISSIPATIV**

Logistical requirements

Location and transport

Requirement due to
IEC 61340-5-3

Type of coating

Procurement

Product / Component



Transport Packaging

Storage Packaging

Transport Packaging



Inside an EPA & ESD-Area

(EPA = Electrostatic Protected Area,
ESD = Electrostatic Discharge)

» **conductive**

$$1 \times 10^2 \text{ Ohm} \leq R_s < 1 \times 10^4 \text{ Ohm}$$

or

» **dissipative**

$$1 \times 10^4 \text{ Ohm} \leq R_s < 1 \times 10^{11} \text{ Ohm}$$

Outside an EPA / unmonitored areas

(regular properties)

» **conductive**

$$1 \times 10^2 \text{ Ohm} \leq R_s < 1 \times 10^4 \text{ Ohm}$$

or

» **dissipative**

$$1 \times 10^4 \text{ Ohm} \leq R_s < 1 \times 10^{11} \text{ Ohm}$$

and

» **protection against discharge**

$$< 50 \text{ nJ}$$



CORTRONIC® ($10^7 - 10^8$ Ohm incl. shielding)

CORSTAT™ ($10^5 - 10^6$ Ohm incl. shielding)

DISSIPATIVE ($10^7 - 10^{11}$ Ohm)

CORTRONIC® ($10^7 - 10^8$ Ohm incl. shielding)

CORSTAT™ ($10^5 - 10^6$ Ohm incl. shielding)



Ready-to-use packaging and containers out of our stock program (see following pages)

Your advantage: quick delivery, no tool-costs, small quantities possible



Individual Solutions



Please contact your dealer / sales consultant (see last page)

We are able to produce customized solutions regarding your wishes:
size, quantities, print etc.

CORSTAT™ CORTRONIC®

Containers For Shipment

Standard color: blue



PCB transit boxes with printed warning

CORTRONIC® Assembled boxes lined with conductive profiled soft foam and conductive pin-insertion foam

Ref	Inner dimensions, mm		
01-TVS	40	40	15
02-TVS	62	62	25

CORTRONIC® Flat packed boxes, empty

Ref	Inner dimensions, mm		
05-TVS	100	55	25
10-TVS	183	127	38
15-TVS	178	127	64
20-TVS	190	135	40
30-TVS	250	191	38
40-TVS	250	191	64
45-TVS	250	191	110
50-TVS	267	216	64
55-TVS	300	300	100
57-TVS	380	280	60
60-TVS	420	220	40
65-TVS	420	220	65



Inserts for PCB transit boxes

Profiled Foam

Profiled 20 mm,
dissipative pink foam

Flatpac

Dissipative stretch film
base to hold PCB or flat
components

Ref	Ref
05-NS as	05-DFP*
10-NS as	10-DFP
15-NS as	15-DFP
20-NS as	20-DFP
30-NS as	30-DFP
40-NS as	40-DFP
45-NS as	45-DFP
50-NS as	50-DFP
55-NS as	55-DFP
57-NS as	57-DFP
60-NS as	60-DFP**
65-NS as	65-DFP**

* Dissipative function of profiled foam lasts 6 months

* Dissipative function of the foil lasts appr. 6 months

** on request

On Request: Inserts for TVS



Foam bar dissipative

assembled in corresponding TVS

Foam grid dissipative

assembled in corresponding TVS

Korrvu Conductiv

CORTRONIC® Transit box
incl. fixing foil

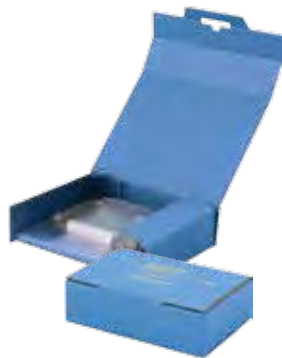

Ref	Inner dimensions, mm		
20-KC	125	107	25
30-KC	160	127	34
40-KC	235	175	45
50-KC	282	228	70
60-KC	360	245	70

* Dissipative function of the foil lasts appr. 6 months

Shipment boxes

CORTRONIC®
with printed warning



Ref	Inner dimensions, mm		
10-TKVS	135	195	25
20-TKVS	135	195	65
30-TKVS	268	190	45

COR-Pack with printed warning
CORTRONIC® Transit box
with dissipative profiled foam* (20 mm) or
conductive foam



Ref	Inner dimensions, mm		
05-TCP	150	115	40
10-TCP	200	140	50
20-TCP	280	140	100

* Dissipative function of pink profiled foam lasts 6 months

Component boxes

with printed warning

CORTRONIC® Transit box

with conductive foam:

- a) PE-foam (6 mm) + profiled foam (10 mm)
- b) PE-foam (6 mm)
- c) Profiled foam (10 mm) continuously

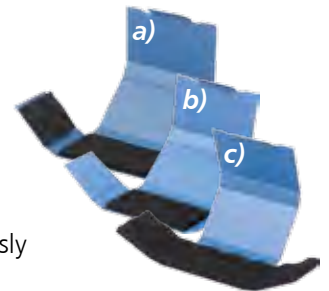

Ref	Inner dimensions, mm		
05-TEP	95	30	15
10-TEP	100	60	15
15-TEP	100	60	30
20-TEP	120	100	15
30-TEP	155	70	25



AVAILABILITY

of our complete product range of
CORSTAT™ und **CORTRONIC®**
from stock



CORSTAT™ CORTRONIC®

Container For Production And Storage

Outside of container is treated with water-/scratch-resistant coating

Standard color: black

Reel Box CORSTAT™

Ref	Inner dimensions, mm			Reels Ø mm
10-CRB	380	180	100	180, max. 16 Reel
30-CRB	355	286	220	380, max. 5 Reel

Ref	Inner dimensions, mm			Reels Ø mm
10-CRM	330	319	220	380, max. 8 Reel



IC bar magazine

CORSTAT™

CORSTAT™ coated, double-sided
stackable, 5 slots

Ref	Inner dimensions, mm			Outer dimensions, mm		
10-ICM	336	586	35	399	599	39



Tube Box, closed, CORSTAT™

for IC bars, with printed warning

Ref	Inner dimensions, mm			Outer dimensions, mm		
05-CTB	600	95	45	610	113	51
10-CTB	590	95	95	600	113	101



Tube Box Fifo CORSTAT™

for IC bars

Ref	Inner dimensions, mm			Outer dimensions, mm with lid		
10-CFI	600	50	100	623	75	106



Storage box, open CORSTAT™

Ref	Inner dimensions, mm			Outer dimensions, mm		
05-CLBO	180	62	65	202	70	70
10-CLBO	285	150	110	305	159	115
15-CLBO	292	109	122	313	116	127
20-CLBO	580	65	65	600	73	66
30-CLBO	592	109	122	611	117	127
40-CLBO	592	153	70	611	161	75
45-CLBO	590	200	180	609	209	185
50-CLBO	615	100	130	634	108	135



Accessories For Production, Storage And Shipment

Horizontal divider

for 48 / 50-TSC, CSC, MB, **dissipative**, black with 2 bevelled corners



Ref	Dimensions, mm	
05-DZW	357	246
10-DZW	550	350

Ring binder

dissipative, blue, DIN A4



Ref	Inner dimensions, mm		
10-DRO	317	245	30

Adhesive tape, black

needed to erect 30, 40, 45 and 50-TSC



Ref	Length m	Width mm
10-KB	66	50

Hanging files ESD Folder

dissipative, black for documents



Ref	Dimensions, mm	
10-DF	564	319

Label holder

dissipative, self-adhesive, clear frosted, further dimensions on request

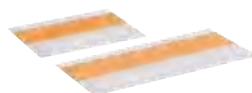

Ref	Dimensions, mm	
05-LT	140	100
10-LT	210	100

Loose-leaf binder

dissipative, black for documents



Ref	Dimensions, mm		
10-DSH	315	235	8

CORSTAT™ CORTRONIC®

Container For Production, Storage And Shipment

Standard color: black

In-plant handler CORTRONIC®

with printed warning



It is possible to double the width of the compartments by removing longitudinal partitions. Partitions are static dissipative. For 30, 40, 45 and 50-TSC adhesive tape is needed (sold separately)

Ref	Inner Dimensions, mm			Cell dimensions, mm			No. of cells	No. of short dividers	No. of long dividers	Outer Dimensions, mm <small>with lid</small>			
	L	W	H	L	W	H				L	W	H	
10-TSC	270	169	195	130	24	195	12	1	5	297	181	204	
				265	24	195	6	5					
15-TSC	372	388	84	109	18	84	60	19	4	400	400	100	
				165	18	84	40	19	3				
20-TSC	386	386	176	110	30	175	30	4	9	415	405	190	
				168	30	175	20	3	9				
				340	30	175	10	2	9				
				*	353	30	175	10	2				9
30-TSC	386	386	358	168	35	350	18	8	3	415	405	365	
				340	35	350	9	8	2				
40-TSC	424	272	281	178	18	280	22	3	10	450	290	290	
				365	18	280	11	2	10				
				*	117	22	280	30	16				3
				*	238	22	280	15	16				2
45-TSC	493	390	166	178	45	166	20	9	3	510	410	175	
				360	45	166	10	9	2				
48-TSC	562	355	150	123	24	150	44	5	10	595	380	160	
				165	24	150	33	4	10				
				250	24	150	22	3	10				
				515	24	150	11	2	10				
50-TSC	562	355	329	123	24	325	44	5	10	595	380	335	
				165	24	325	33	4	10				
				250	24	325	22	3	10				
				515	24	325	11	2	10				

* on request

Tray CORSTAT™

Stackable, Made to fit 48-TSC and 50-TSC / CSC boxes.

Either with or without foam.

Use code suffix: as = dissipative el = conductive

Ref	Inner dimensions, mm			Outer dimensions, mm		
05-CTR	297	230	28	351	246	31
06-CTR	297	230	55	351	246	60
07-CTR	305	243	40	358	259	43
20-CTR	499	330	28	550	346	31
25-CTR	499	330	40	550	346	43
30-CTR	499	330	70	550	346	73
EE-flute with CORTEC coating						
20-CTR EE	499	330	28	550	346	

Cover (solid board)

20-30-CTR D	593	343
--------------------	-----	-----



CTR partition inserts (solid board) CORSTAT™

Ref	Dimensions, mm - all over			Cell dimensions mm	No. of cells	No. of short partitions	No. of long partitions
	L	W	H				
05-CTR Set	295	228	28	20 × 21	130	12	9
20-CTR Set	497	328	28	20 × 20	330	21	14



AVAILABILITY

of our complete product range of
CORSTAT™ und **CORTRONIC®**
from stock

CORSTAT™ CORTRONIC®

Container For Production, Storage And Shipment

Outside of container is treated with water-/scratch-resistant coating

Standard color: black

Multibox CORTRONIC® and CORTEC

Ref	Inner dimensions, mm			Outer dimensions, mm		
10-MB	565	365	109	591	391	114
20-MB	565	365	209	591	391	214



Multibox lid CORTRONIC® and CORTEC

Ref	Inner dimensions, mm			Outer dimensions, mm		
10-20-MBD	593	393	50	603	397	53



Multibox partitions

for 10-20-MB

Ref	Cell dimension, mm all over			No. of cells max.	No. of short partitions	No. of long partitions
	L	W	H			
100/200-MB-K or L, height of divider is ref.-nr.	50	20	100-200	138	22	7
				No. of slots		
Short partition	352		100-200	7		
Long partition	552		100-200	22		
Partitions singly available, individually sized compartments possible						

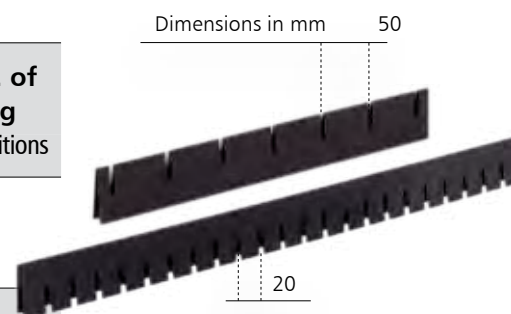

Customer-Store-Container in colorful variety

CORTRONIC® - can be used with or without lid

Ref	Inner dimension, mm (without stacking lug)			Outer dimension, mm (without stacking lug and lid)		
03-CSC	362	251	60	389	278	67
05-CSC	362	251	100	389	278	107
10-CSC	362	251	139	389	278	146
15-CSC	362	251	220	389	278	227
17-CSC	551	362	60	578	389	67
19-CSC	551	362	100	578	389	107
20-CSC	551	362	139	578	389	146
30-CSC	551	362	172	578	389	179
35-CSC	551	362	220	578	389	227
36-CSC*	550	365	300	578	389	307
40-CSC*	550	365	400	578	389	410

* For 36-CSC and 40-CSC no dividers available



Colorful variety:

- » Red
- » Blue
- » Green
- » Black

Customer-Store lid CORTRONIC®

Ref	Inner dimensions, mm			Outer dimensions, mm		
03-15-CSCD	388	281	30	399	299	35
17-40-CSCD	581	392	40	599	399	45



On request:

- » Sliding boxes
- » Box-in-box solutions
- » Ready-to-use solutions

Container-Inserts For CSC

Standard color: black

CSC partition inserts (solid board) CORSTAT™ – for 03-15 CSC

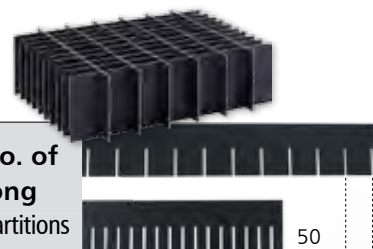

Ref	Cell dimension, mm all over			No. of cells max.	No. of short partitions	No. of long partitions
	L	W	H			
e.g. 03-CSCK or L box name is ref.-no.	50	20	60-100-139-220	77	6	10

Dimensions, mm
Slot width: 2 mm

No. of slots			
Short partition	249	60-100-139-220	10
Long partition	360	60-100-139-220	6

Partitions singly available, for this reason individually sized compartments possible. Available assembled or disassembled.

CSC partition inserts (solid board) CORSTAT™ – für 17-35 CSC

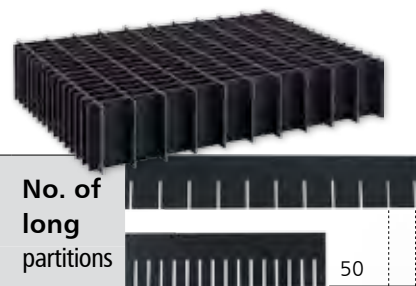

Ref	Cell dimension, mm all over			No. of cells max.	No. of short partitions	No. of long partitions
	L	W	H			
e.g. 17-CSCK or L box name is ref.-no	50	20	60-100-139-172-220	160	11	15

Dimensions, mm
Slot width: 2 mm

No. of slots			
Short partition	360	60-100-139-172-220	15
Long partition	549	60-100-139-172-220	11

Partitions singly available, for this reason individually sized compartments possible. Available assembled or disassembled.

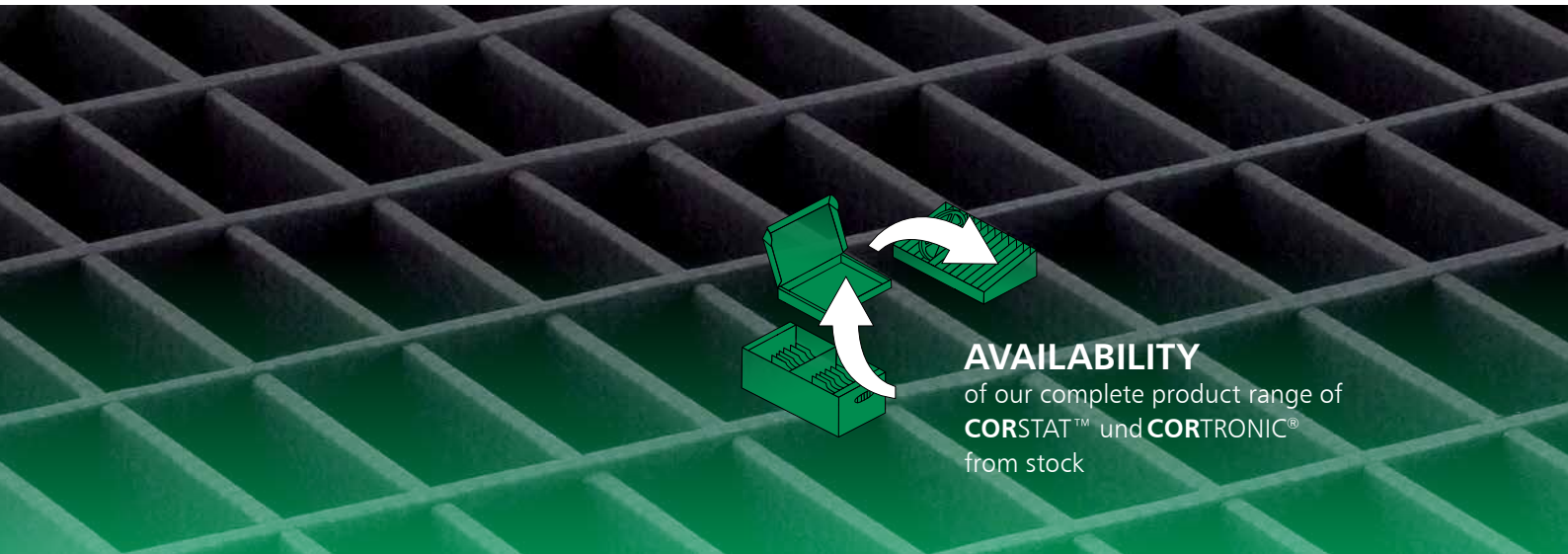

AVAILABILITY
of our complete product range of
CORSTAT™ und **CORTRONIC®**
from stock

Profiled foam for CSC

dissipative pink* (on request: black, conductive)

Ref	Dimensions, mm		
03 bis 15-CSC	361	250	20
17 bis 40-CSC	550	361	20

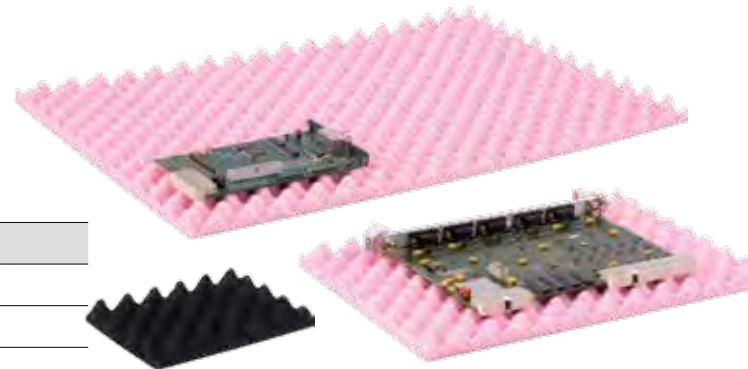

* Dissipative function of pink profiled foam lasts 6 months

CSC inserts „Box in Box“ CORSTAT™

for 17 CSC and 19 CSC

Re	Dimensions, mm			No. of boxes per container
17-CB1/8	162	119	56	8x
17-CB1/4	256	162	56	4x
19-CB1/8	163	128	95	8x
19-CB1/4	265	163	95	4x



CORSTAT™ CORTRONIC®

Standard Products Made For Quick Supply

Custom-made items meet your special needs!

Some ESD sensitive products have special packaging or handling requirements. **CORTRONIC®**'s versatility makes it possible for us to meet all your requirements, whether from stock or custom-made.

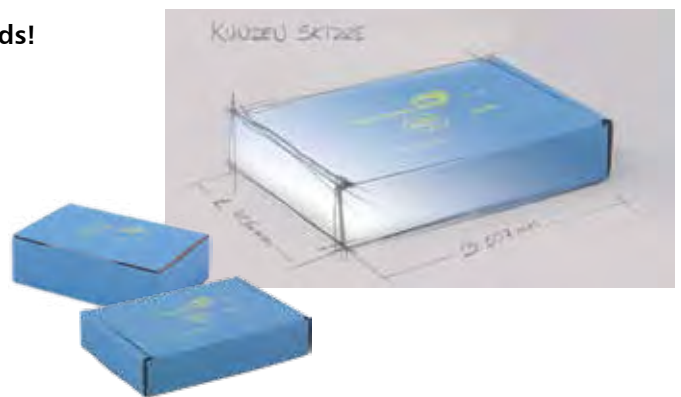

For shipping ESD sensitive parts:

- » EPROM packaging
- » Dispatch boxes with profiled foam or foil
- » Constructive dispatch boxes
- » **CORPACK** with profiled foam

For production, in-plant handling and storage:

- » Stackable boxes
- » Trays
- » Reels, reel holders
- » Storage boxes open and storage boxes stackable
- » Partitioned boxes
- » Multibox
- » Fifo-Box

Worldwide availability!

CORSTAT™ and **CORTRONIC®** are used over decades in all parts of the world. Just call us or visit us on the web to find your next dealer.



Quick
Delivery Service



CORRUST®



Corrosion Protection Of The Future

VCI Corrosion Protection Included

Protection against rust

Rust destroys metal. Rust is generated when sulphur dioxide and chloride are oxidised – such as by exposure to humid air. Therefore corrosion protection particularly is important when transporting and storing ferrous and non-ferrous metals for longer periods of time.

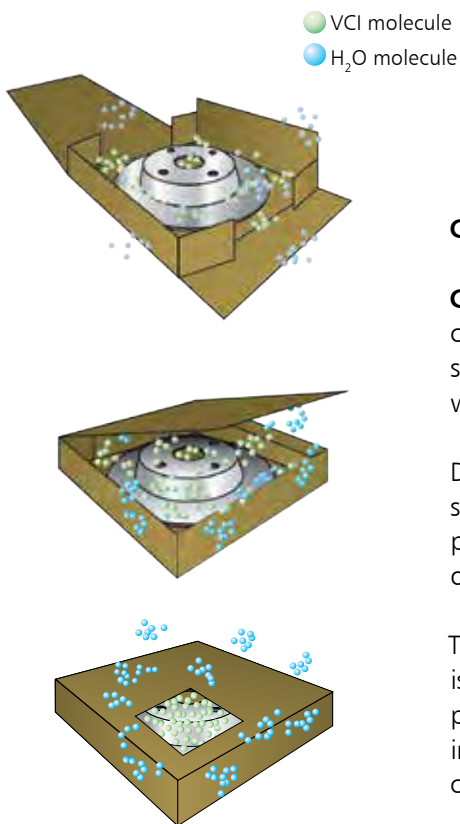

CORRUST® – A forward thinking principle

CORRUST® is a packaging system made from VCI-coated corrugated cardboard. This generously applied coating releases VCI molecules into the atmosphere inside the packaging – which subsequently comprises the actual corrosion protection.

Due to their polar character, these molecules attach to the surface of the metal products inside the packaging and thus prevent (passivate) the metal surface from reacting with oxygen.

The VCI coating applied to the corrugated cardboard is adjusted specifically to the packaging's relevant purpose and therefore ensures that the packaging's interior is always adequately saturated with VCI, and consequently provides long time protection for your product.

VCI: Volatile Corrosion Inhibitor

» PROTECTION INCLUDED

Packaging with VCI corrosion protection is extremely easy to use and gives you a real competitive advantage. **CORRUST®** packaging systems ensure smooth logistics processes with a significantly improved way to maintain the quality of your corrosive products

Protecting the environment

Corrosion damage not only affects trade, but also has an impact on the environment. **CORRUST®** is 100% recyclable and therefore ideal for humans and the environment, but also a safe choice when it comes to logistic costs.

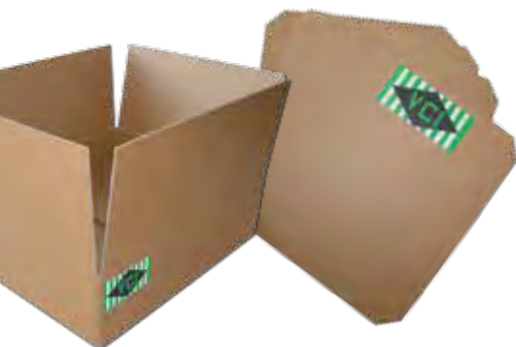

We are able to simulate your shipment process in all relevant climate conditions to assure the best possible protection of your products.

Wrap - unwrap - and not a spot of rust inside

Traditionally, anti-corrosion packaging for transporting and shipping metal products entails coating a product in grease or a similar corrosion-inhibiting substance, then wrapping it, and then removing the coating again – all of which takes up quite a lot of time, which, ultimately, can drastically impact on the entire logistics chain. However, **CORRUST®** anti-corrosion packaging now makes this labour-intensive process a thing of the past, does not require any investments in corresponding washing systems or solvents and has been reduced to just that: Wrap, unwrap – and not a spot of rust in sight!



CORRUST®

Safety

Corrugated cardboard packages are hygroscopic, i.e. they attract and absorb moisture from the air. This is an extremely useful feature since the cardboard can thus be used to hold large quantities of VCI. The **CORRUST®** VCI coating then forms a perfect barrier between the corrugated cardboard and the product inside. **CORRUST®** packaging systems can also, on request, be supplied with a moisture-repellent coating on the outside, which makes the system even more efficient for transporting products under difficult climatic conditions.



Protection categories

E

For protecting ferrous metals, chromium, nickel, silicon aluminium alloys, partially galvanized steel, GGL and GGG

NE (S)

For protecting magnesium and magnesium alloys, silver and manganese

NE (C)

For protecting copper, brass, bronze, nickel silver, copper and manganese aluminium alloys

MM

For protecting combinations of ferrous and non-ferrous metals, zinc and manganese aluminium alloys, galvanized steel, zinc and copper materials

Example products



Pre-cuts / sheets

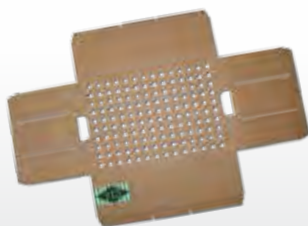

Cut to size



Partitions / Inserts



RSC / American Boxes

SKINBOARD®
CORRUST SKINBOARD®



Skin Tight Protection

SKINBOARD® CORRUST SKINBOARD®

Product Safety And Outstanding Presentation.

With **SKINBOARD®** tight skin foil wrapping, excellent fixture of the goods on the board is combined with attractive product presentation. The foil and the corrugated cardboard are sealed together by what is known as fibre cut.

This bonding method determines the characteristic properties of the packaging: When unpacking the product, a layer of paper remains attached to the foil, making the **SKINBOARD®** packaging very easy to handle.

Thanks to the use of high-strength adhesive, even heavy parts can be safely fixed to the cardboard for attractive presentation and increased sales.



Versatile skin packaging

*Strong, variable and functional:
Introducing the professional packaging
solution for your fragile products.*

*SKINBOARD® is a coated
corrugated board with
enhanced adhesion properties
for skin film packaging*



Options included as standard!

Release function:

For small fragile parts of low weight, the strength of the bond between the film and the cardboard must be reduced to a defined value. Special coats ensure that even the most delicate products can be properly positioned on the board and can be easily removed.

*SKINBOARD® is suitable for
packaging with skin foils
made in PE and Surlyn®.*



»» GUARANTEED QUALITY

As a product engineer for technically advanced components that are susceptible to corrosion, I trust **CORRUST® SKINBOARD®** packaging from HANS KOLB Wellpappe.

CORRUST SKINBOARD®

CORRUST SKINBOARD® products offer optimised protection against corrosion for sensitive products. The corrosion protection properties can be individually chosen, depending on the material properties of the packed goods.

We offer the following options:

- » Steel/iron, chromium
- » Brass, copper, bronze
- » Magnesium and magnesium alloys, silver
- » Multi-metal protection for products made from various metals



SKINBOARD®

CORRUST SKINBOARD®

The perfect solution

The coated corrugated cardboard of the **KOLB CoatedProducts®** range is the ideal material for protective and sturdy packaging for products that are easily damaged by impact. It offers a range of advantages and thus meets the requirements of customers in a wide range of industries.

With **SKINBOARD®** we offer you an innovative product made in functional corrugated board that can be printed with your individual designs..

SKINBOARD® and **CORRUST SKINBOARD®** are suitable for combination with all current skin foils. For **CORRUST SKINBOARD®** we recommend using VCI skin foils.

To develop your customised packaging solution, we need the following information:

- » Properties of goods to be packed (material properties, size and weight)?
- » Required skin format?
- » Corrosion protection required?
- » Quantity?
- » Printing required?

If desired, we produce a sample packaging for your products free of charge. Why not visit our premises to discuss your ideas with us and to see how **SKINBOARD®** is processed on our skin packaging machine?

Thanks to a skin tight foil cover the product will be both packed and presented in an outstanding manner.





VCI – Volatile Corrosion Inhibitor



VCI stands for vapour and volatile corrosion inhibitor and describes a process by which molecules from the skin/VCI coating evaporate and saturate the air inside the packaging. Due to their bi-polar character, these particles attach themselves to the surface of the metal products and fill recesses, thus preventing chemical reactions with oxygen on these surfaces (passivation).

- Particles lost through evaporation are replaced by evaporation of more VCI molecules from the coating, so that saturation of the air inside the packaging is ensured at all times.

Result: Dry preservation of the product, doing away with time-consuming and costly conventional preservation and cleaning measures.



SKINBOARD® CORRUST SKINBOARD®

Skin packaging – on corrugated cardboard carrier material

» Advantages:

- » Highly dynamic protection for products that are sensitive to shock
- » Excellent stability thanks to fluted profile
- » No disintegration of the corrugated cardboard layers by the foil restoring forces (special gluing of the individual paper layers)
- » Integrated corrosion protection (with **CORRUST SKINBOARD®**)
- » Recyclable (paper cycle)
- »

» The skin surface:

- » Optimum bonding between corrugated cardboard and foil
- » Outstanding vacuum properties
- » Suitable for multicolor print on both sides

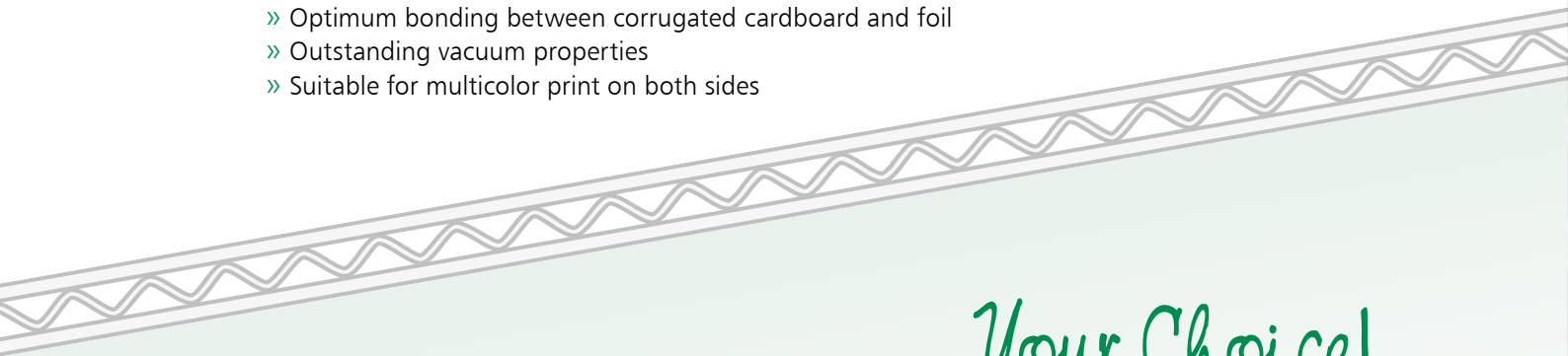

Your Choice!

The size:

All skin sizes

The board type: (Scale 1:1)

E-Flute



B-Flute



C-Flute



FE-Flute



EE-Flute



EB-Flute



BC-Flute



The skin layer:

SKINBOARD® or **CORRUST SKINBOARD®**

The finish:

Color / print pattern



Types, Sizes, Dimensions



CORRUST®

CORRUST® corrugated cardboard packaging systems can be supplied in all shapes and sizes with features and properties most suited to meet your specific requirements. There is only one thing they all have in common: A high level of corrosion protection!

CORRUST SKINBOARD®

CORRUST SKINBOARD® features fully integrated corrosion protection and therefore offers maximum protection for vacuum-packed products.

CORRUST® Flex

This flexible VCI corrugated cardboard has been specifically designed to allow products with irregular shapes to be easily packaged and offers them maximum corrosion protection.

All **CORRUST®** packaging systems are available in all of the most common DIN corrugated cardboard types and/or – depending on their intended use – can be made specifically and totally to your specifications.



Product information

The above information is correct to the best of our knowledge and reflects the latest **CORRUST®** developments. Depending on the product to be packaged, the basic features of the different **CORRUST®** packaging types may vary. We are therefore unable to provide a universal warranty for our products. However, we are always happy to conduct tests with our customers to ascertain the level of corrosion protection needed for specific packaging solutions.



KOLB CoatedProducts®

No „entry“:

With special coatings against moisture not only your product will be protected – even the area around the Air-Pet-Box is secured of „animals moisture“ in nervous situations.



Grease, moisture and mould – we have something against them!

Grease-resistant coating

Oily and greasy products such as ball bearings should be safely and securely packed throughout dispatch and storage. Thanks to the grease-resistant coating system from **KOLB CoatedProducts®** protection from grease is guaranteed throughout the entire duration of logistics and dispatch.

Moisture-resistant coating

Moisture is the natural enemy of corrugated board packaging. But not where the moisture-resistant special coating on **KOLB CoatedProducts®** is concerned. Special hardened varnish creates a highly efficient barrier against any kind of moisture.

Anti-mould coating

To prevent the formation of fungus or mould we have developed storage containers that provide the maximum possible product protection even in damp and badly ventilated storage atmospheres.

Wax coating

Whether as an insert or a complete export package, products can be sent on their way securely packed thanks to a special wax coating – even in hard climatic conditions.

Variety for all needs:

Different parafinum coatings are the perfect protection as you like it.

FlameRetard

is our name for the flame-retardant coated corrugated board for display presentations and packaging for packed items with special security requirements.

Depending on your requirements we will reach several building classes.



Stop & Go: non-slip and sliding coatings

Packages or intermediate layers that have adhesive or gliding properties are used either to fix goods during transport or for the horizontal automatic loading of boxes and trays. Two different coatings provide different results, but they have one thing in common: process optimization and the simplification of your packaging process. Rub-resistant coatings also help you to send even rough items safely.

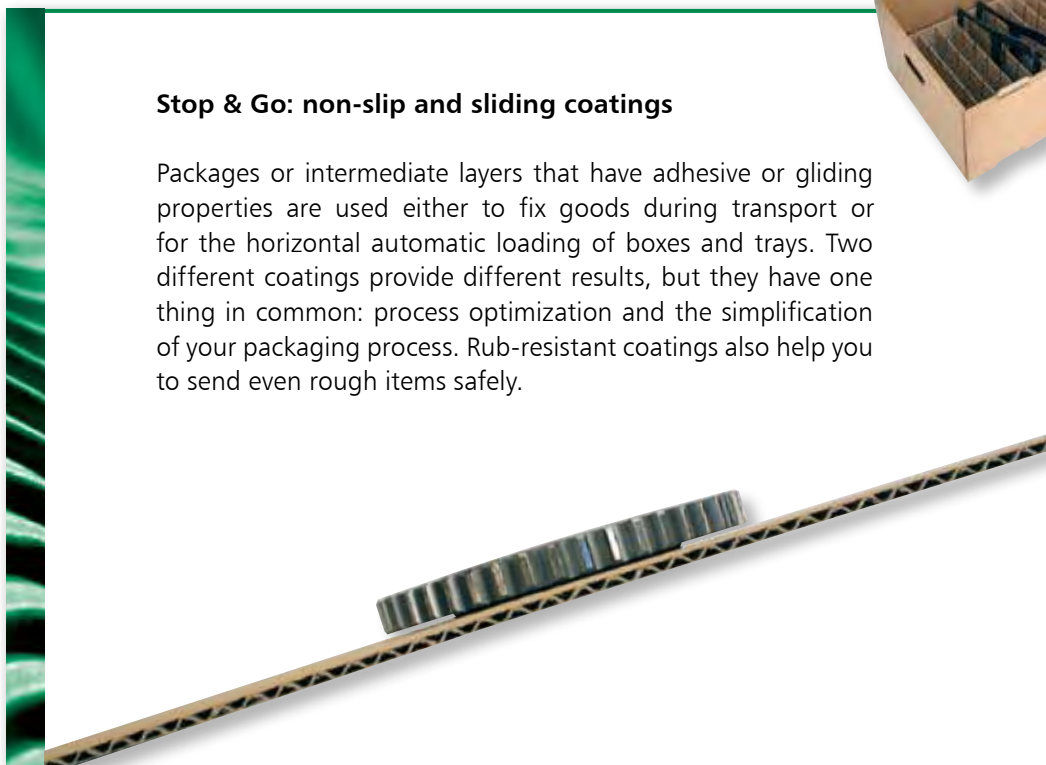

KOLB CoatedProducts®

Hard & Soft:

Surface protection and secure transport for your product

Soft coatings serve to protect surface-sensitive goods. The slip-resistant function also has a positive effect on transport safety. Varnished and sensitive parts will be securely packed in a perfect manner.

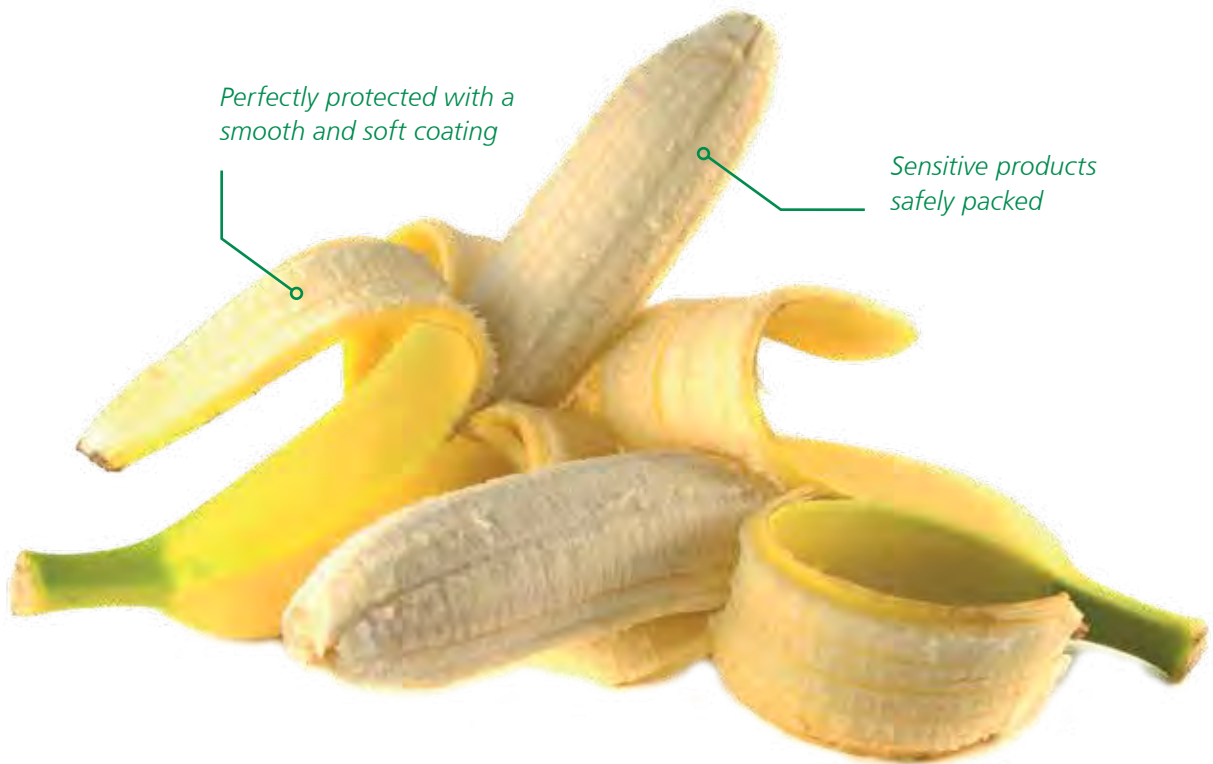

KOLB Logistics & Service



Service for advanced

The reputation of the **KOLB** Group is not only based on its high-quality products. But the quality approach also covers all aspects of delivery and just-in-time availability of our goods.

The **KOLB Logistics** department has at its disposal a vehicle fleet with more than 40 trucks, and can thus guarantee just-in-time delivery and efficient order handling.

We are furthermore glad to assist you in every demand regarding packaging automation, co-packing and many more topics of state-of-the-art packaging processes.

*Our aim is
„besser verpacken“
Packaging which is simply
better, made by
HANS KOLB Wellpappe.*

HANS KOLB Wellpappe GmbH & Co. KG
Dr.-Lauter-Straße 2
D-87700 Memmingen

Tel. +49 8331 975-0
Fax +49 8331 975-235
info@kolb-wellpappe.com

HOTLINE:

KOLB CoatedProducts®
Tel. +49 8331 975 – 308
E-Mail: cp@kolb-wellpappe.com

Our further packaging specialists at a glance

KOLB Packaging
Tel. +49 8331 975 – 234
E-Mail: packaging@kolb-wellpappe.com

KOLB Print+
Tel. +49 8331 975 – 234
E-Mail: print@kolb-wellpappe.com

KOLB Specials
Tel. +49 8331 975 – 395
E-Mail: specials@kolb-wellpappe.com

KOLB Display
Tel. +49 8331 975 – 234
E-Mail: display@kolb-wellpappe.com